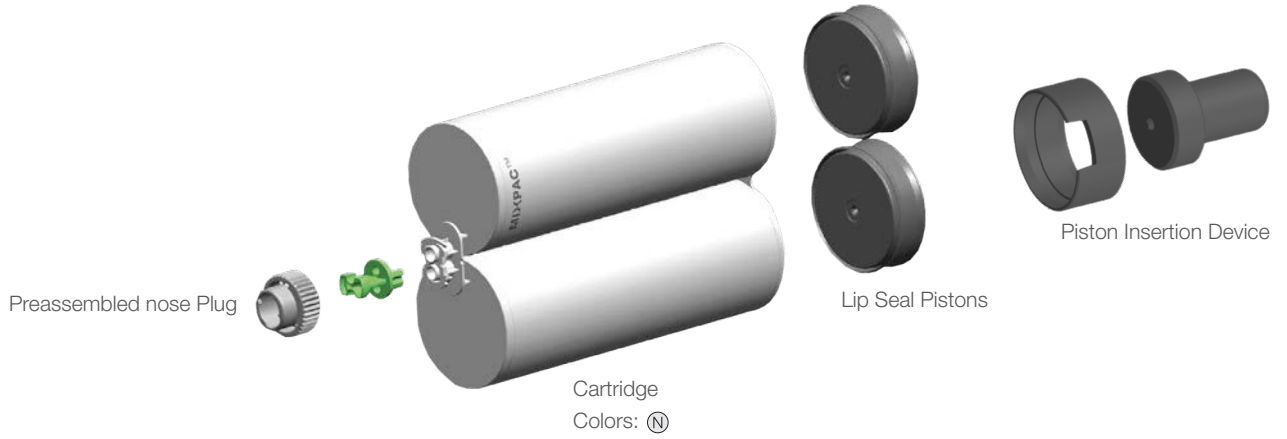

Table of Contents

Coating Cartridge Sets	2
Mixers	3
Dispensers and Accessories	4

MIXPAC™ MixCoat™ Coating Cartridge Set







Ratio Set/ Volume	ID	Article	Cartridges Material/Color	Lip Seal Pistons	Units/Pallet	Mixer Technology	Matching Dispenser
1:1 1500mL	153493	AF 1500-01-14-01	PP/ (N)	Self-venting	418	all	all
	128218	AF 1500-01-30-01	PA/ (N)	Self-venting	418	all	all
2:1 1125mL	153469	AF 1125-02-14-01	PP/ (N)	Self-venting	532	all	all
	128074	AF 1125-02-30-01	PA/ (N)	Self-venting	532	all	all
3:1 1000mL	153495	AF 1000-03-14-01	PP/ (N)	Self-venting	627	all	all
	128216	AF 1000-03-30-01	PA/ (N)	Self-venting	627	all	all
4:1 940mL	153494	AF 940-04-14-01	PP/ (N)	Self-venting	684	all	all
	128080	AF 940-04-30-01	PA/ (N)	Self-venting	684	all	all







Piston Insertion Device

Ratio Set/ Volume	ID	Article
1:1 1500mL	128332	PIDQ 1500-01-01
2:1 1125mL	128635	PIDQ 1125-02-01
3:1 1000mL	117269	PIDQ 1000-03-01
4:1 940mL	128634	PIDQ 0940-04-01

Matching dispensers

	ID	Article	Ratio			
			1:1	2:1	3:1	4:1
DM dispenser manual 	128966	DM 1500-01	✓	✓	✓	✓
DPD dispenser pneumatic 	128962	DPD 1500-01	✓	✓	✓	✓
DPS dispenser pneumatic spray 	128963	DPS 1500-01	✓	✓	✓	✓
DPF dispenser pneumatic flex spray 	128965	DPF 1500-15	✓	✓	✓	✓
	128989	DPF 1500-30	✓	✓	✓	✓

Matching mixers

	ID	Article	Number of Elements	Inner Diameter Ø mm/ inch	Length m/feet	Units/ Box	Check Valve	Spray			Brush	
							Dual	Angle, MF	Angle, HF	MF	HF	Long Handle
1:1/2:1/3:1/4:1 FHB 	161982	FHB 01-15-06	24	8.7/0.343	1.5/4.9	20	✓					✓
	161983	FHB 01-15-07	24	8.7/0.343	1.5/4.9	20	✓				✓	
1:1/2:1/3:1/4:1 FHS 	161984	FHS 01-15-M-02	24	8.7/0.343	1.5/4.9	20	✓			✓		
	161985	FHS 01-15-MA-02	24	8.7/0.343	1.5/4.9	20	✓	✓				
	161986	FHS 01-30-M-02	24	8.7/0.343	3.0/9.8	20	✓			✓		
	161987	FHS 01-30-MA-02	24	8.7/0.343	3.0/9.8	20	✓	✓				
1:1 DFL 	154264	DFL 01-15			1.5/4.8	5	✓					
	154262	DFL 01-30			1.5/4.8	5	✓					
1:1/2:1/3:1/4:1 MFH 	154145	MFH 08-32C-13	32	8.0/0.315		400	✓			✓		
1:1/2:1/3:1/4:1 MFQ 	151717	MFQ 07-18C-06	18	7.5/0.295		500					✓	
	161980	MFQ 07-18C-12	18	7.5/0.295		500	✓				✓	
	128112	MFQ 08-24C-06	24	8.7/0.343		500					✓	
	128113	MFQ 08-24C-07	24	8.7/0.343		500				✓		
	129438	MFQ 08-24C-12	24	8.7/0.343		500	✓				✓	
	129439	MFQ 08-24C-13	24	8.7/0.343		500	✓			✓		
	161981	MFQ 08-24D 2CV	24	8.7/0.343		500	✓					
1:1/2:1/3:1/4:1 MFQA 	128116	MFQA 08-24C-06	24	8.7/0.343		500			✓			
	128117	MFQA 08-24C-07	24	8.7/0.343		500			✓			
	161745	MFQA 08-24C-12	24	8.7/0.343		500	✓		✓			
	161746	MFQA 08-24C-13	24	8.7/0.343		500	✓	✓				

MIXPAC™ MixCoat™ Dispenser & Accessories Manual

DM 1500-01



Pos	ID	Article	Description
	128966	DM 1500-01	Dispenser manual
1	129304	SP-D-001	Cartridge retention clips (4 pcs.)
2	129031	SP-D-002	Shoulder strap
3	128993	CK 1500	Converter Kit 1:1, 2:1, 3:1, 4:1 including hex key and screws

MIXPAC™ MixCoat™ Dispenser & Accessories Pneumatic Dispense/Spray

DPD 1500-01

DPS 1500-01

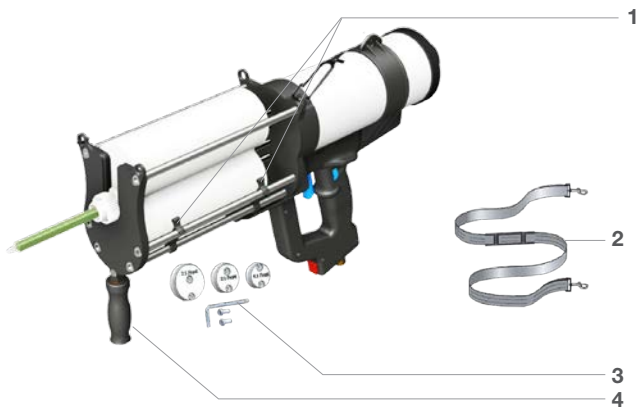

Pos	ID	Article	Description
	128962	DPD 1500-01	Dispenser pneumatic dispense
	128963	DPS 1500-01	Dispenser pneumatic spray
1	129304	SP-D-001	Cartridge retention clips (4 pcs.)
2	129031	SP-D-002	Shoulder strap
3	128993	CK 1500	Converter Kit 1:1, 2:1, 3:1, 4:1 including hex key and screws
4	129305	SP-DPS-003	Adjustable handle
5	129300	SP-DPS-001	Atomizing air tube including quick lock coupling (used with MFQ mixers)
	160112	SP-DPS-004	Atomizing air tube including quick lock coupling (used with MFH mixers)
	151690	SP-DPF-005	Atomizing air tube including quick lock coupling, 1.5m
6	129301	SP-DPS-002	Pneumatic push to connect fitting

MIXPAC™ MixCoat™ Dispenser & Accessories Pneumatic Flex Spray

DPF 1500-15 / DPF 1500-30

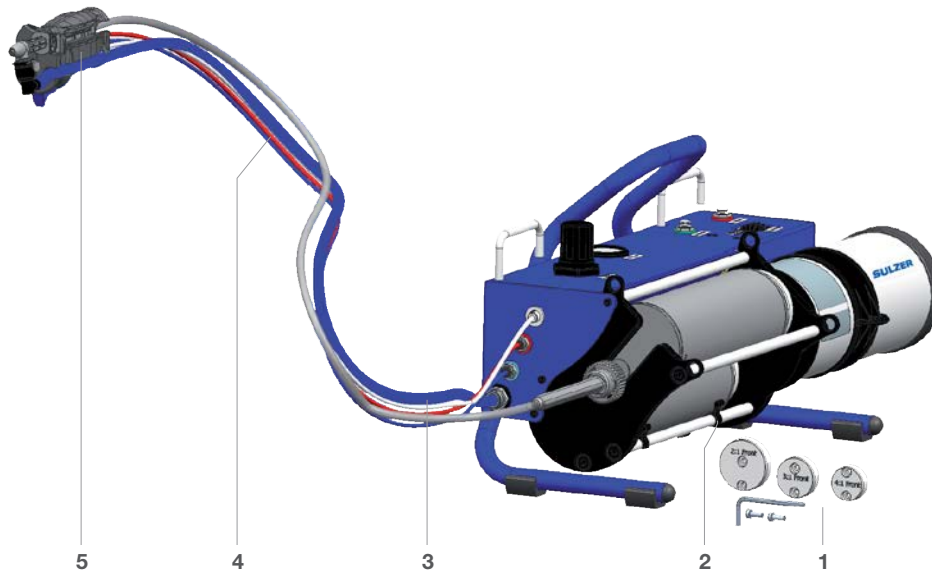

Pos	ID	Article	Description
	128965	DPF 1500-15	Dispenser pneumatic flex spray, 1.5m
	128989	DPF 1500-30	Dispenser pneumatic flex spray, 3m
1	128993	CK 1500	Converter Kit 1:1, 2:1, 3:1, 4:1 including hex key and screws
2	129304	SP-D-001	Cartridge retention clips (4 pcs.)
3	151689	SP-DPF-004	Atomizing air tube including quick lock coupling, 3m
3	151690	SP-DPF-005	Atomizing air tube including quick lock coupling, 1.5m
4	129302	SP-DPF-001	Air tubes preassembled, 1.5m including atomizing air, control air tubes and quick lock coupling for spray mixer connection
	129303	SP-DPF-002	Air tubes preassembled, 3m including atomizing air, control air tubes and quick lock coupling for spray mixer connection
5	128861	SP-DPF-003	Actuator, hand held (excluding air control tubes)